

FOUNDRY PRACTICE

The authoritative magazine for foundry engineers

- SINCE 1932 -



FILTRATION

The incorporation of Additive Manufacturing Technology (3D) in casting filtration, providing optimised efficiency and customization

FILTRATION & GATING

HOLLOTEX* EG Runner ST - The lightweight alternative to ceramic gating systems, now also available for steel casting!

FEEDING SYSTEMS

Application of FEDEX* K on DISAMATIC moulding lines

FEEDING SYSTEMS

Fluoride emission free feeding systems solutions

FEEDING SYSTEMS

The Foseco Pro Module for MAGMASOFT® - Update 2023

EDITORIAL

FOUNDRY PRACTICE 275

Dear Readers,

It is my privilege to introduce this special GIFA Edition of FOSECO Foundry Practice - in fact, this is now our 275th Edition of the publication. Whilst the look and design of Foundry Practice has changed significantly over the last 90 or so years, it continues the tradition of highlighting our latest technical innovations and solutions to the challenges faced by our customers.

This edition focuses on our Methoding Products, Feeding Systems and Filtration solutions for Ferrous castings and describes new products and application technologies to improve casting quality, reduce environmental impact and increase productivity.

The first article describes an exciting new patented technology for the filtration of Iron and Steel castings - STELEX* Optiflow3D. The filters are produced using Additive Manufacturing, which allows significant freedom in terms of geometry and pore design of the structure. For the first time it is possible to design filters which can be optimised for individual castings, in terms of filtration efficiency, metal capacity and flow rate.

HOLLOTEX* EG Runner ST is a new lightweight alternative to conventional holloware for jobbing steel casting applications. The runner tubes can be cut safely, quickly, and easily positioned, with minimum dust, waste, and contamination of the sand system.

Interest in expanding spot-feeding applications to vertically parted greensand lines such as DISAMATIC continues to increase. Here we present two case studies highlighting the yield and productivity advantages of using FEEDEX* K sleeves directly on the swing plate.

Increasing environmental pressure on foundries, particularly in terms of waste sand disposal has driven the development of exothermic feeder sleeves which eliminate or reduce the amount of fluoride entering the sand system. Christof Volks presents a summary of the products and technologies available today.

Finally, we present the latest version the FOSECO Pro Module for MAGMASOFT®, describing the improvements in the user interface and additions to the functionality.

We hope you enjoy the issue!

Ian Delaney
Marketing & Technology Director
Foundry Europe

GET IN TOUCH WITH IAN



CONTENTS

FOUNDRY PRACTICE 275

TECHNICAL ARTICLES

The incorporation of Additive Manufacturing Technology (3D) in casting filtration, providing optimised efficiency and customization

Authors: Nick Child, Foseco International and Stephan Giebing, Foseco Germany

[> to the article](#)

HOLLOTEX* EG Runner ST - The lightweight alternative to ceramic gating systems, now also available for steel casting!

Author: Andreas Baier and Stephan Giebing, Foseco Germany

[> to the article](#)

Application of FEDEX* K on DISAMATIC moulding lines

Author: Christof Volks, Foseco Germany, Marc Mauhay, Foseco Taiwan

[> to the article](#)

Fluoride emission free feeding systems solutions

Author: Christof Volks, Foseco Germany

[> to the article](#)

The Foseco Pro Module for MAGMASOFT® - Update 2023

Author: Máirtín Burns, Foseco France

[> to the article](#)

NEWS

Foseco at GIFA website

[> find out more](#)



THE INCORPORATION OF ADDITIVE MANUFACTURING TECHNOLOGY (3D) IN CASTING FILTRATION, PROVIDING OPTIMISED EFFICIENCY AND CUSTOMIZATION



Authors: Nick Child, Foseco International Limited, Tamworth, UK and Stephan Giebing, Foseco Europe, Borken, Germany

Ceramic foam filters have become the leading choice for metal filtration in casting since the 1980s. They are extensively used across various alloys and casting technologies, providing cleaner castings with improved properties. Over the years, our understanding of filter application has advanced significantly, and guidelines have been developed to ensure their durability. Despite their limitations in pore size and design flexibility, ceramic foam filters outperform other filter types in terms of filtration efficiency and turbulence control. The emergence of additive manufacturing, particularly 3D printing, offers new opportunities for customised filter designs with precise pore sizes and structures, further optimising casting filtration.

INTRODUCTION

Ceramic foam filters (Figure 1) became extensively used in the filtration of castings in the 1980's and are now the leading type of metal filtration system used to produce castings in most alloys and casting technologies.

Over the last 40 years our knowledge and understanding of all aspects of filter application has advanced considerably; filter application is now established in the production of castings of less than 100 g to more than 25 tons. A variety of materials are used as the ceramic base, the selection is based on the alloy to be cast and the required temperature performance. Filters are also commonly applied in "Direct Pour Units" removing the need for a separate running system providing enhanced yield and directional solidification. Application requirements are understood, and guidelines developed, to ensure filters do not break in the very demanding application conditions. Filter limitations are also recognised, including the mechanisms and materials that block filters, so that flow rates and capacities in specific applications can be predicted.

Casting simulation, and flow modelling through computer simulation packages, now provides greater insight into the molten metal flow enhancement generated by filters. The reduction in turbulence decreases the potential for mould erosion and miss run defects, together with reducing exposure to air and the generation of oxide films and inclusions.

Ceramic Foam Filters have restrictions including, pore sizes and limitations in the flexibility in design. Other filter types are commercially available but not extensively used as they in general provide a lower level of filtration efficiency and turbulence control.

ADDITIVE MANUFACTURING TECHNOLOGIES DELIVERING NEW STRUCTURES

Using additive manufacturing technologies (3D Printing) in casting filtration technology, allows for the creation of objects which are built up layer by layer. The term Additive Manufacturing covers a number of different techniques including stereolithography, sheet lamination, and binder jetting. Foseco used a binder jetting technique as the base for launching its first 3D printed filter - STELEX* Optiflow3D (Figure 3).

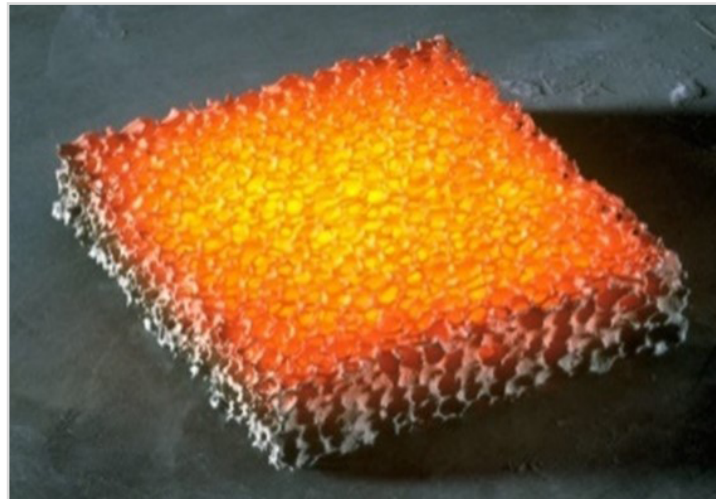

Figure 1. Ceramic Foam Filters

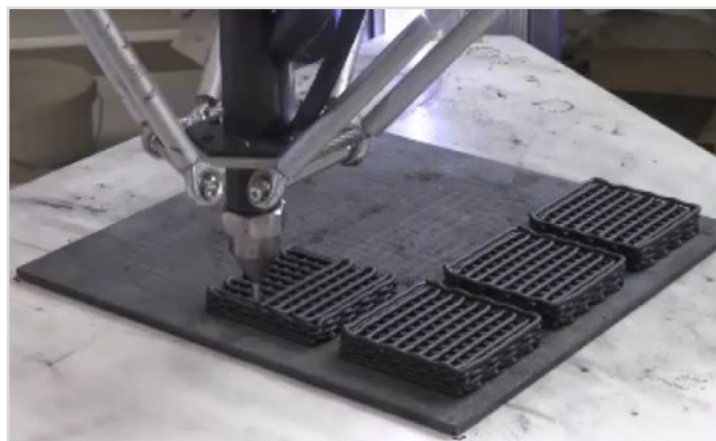

Figure 2. Research into the production of extruded 3D printed filters

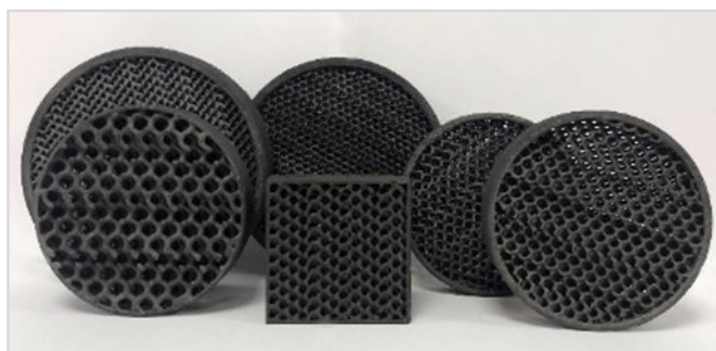

Figure 3. Additive manufactured filters - STELEX Optiflow3D

Ceramic Foam Filters have served the industry very well, but as previously mentioned different alloys and casting types have varying filter performance needs. The first structures to be offered in the STELEX Optiflow3D product range are based on Gyroid and Voronoi structures, the filters are available in an increasing range of product sizes and porosities (Figure 4). STELEX Optiflow3D filters are based on a carbon bonded alumina ceramic and therefore have a low density and thermal heat capacity. The filters are suitable for application to both iron and all steel alloys. Foseco have their own inhouse foundries and have developed tests to replicate some of the most demanding conditions the filters will experience in customers applications. These tests are used both during the development of new products, and for production batch quality control during manufacturing, to ensure confidence that the required performance standards have been met for application by our customers (Figure 5).

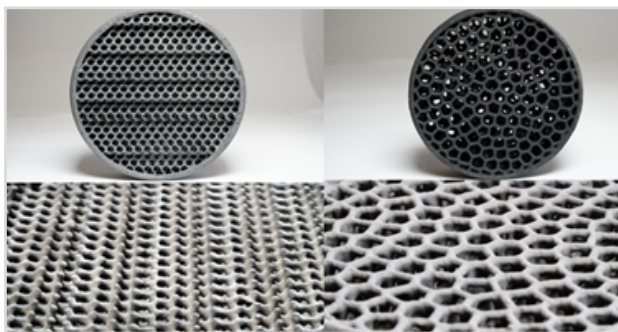

Figure 4. STELEX Optiflow3D available in a range of structures and sizes

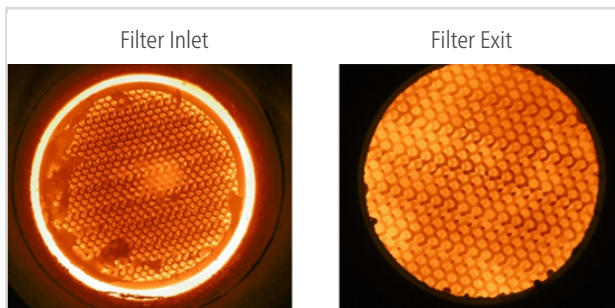

Figure 5. STELEX Optiflow3D after R&D testing with molten stainless steel

Additive manufactured filters extend the range of castings that are filterable. Very large castings are commonly not filtered due to the complexity of applying the large number of filter units required. With the advent of alternative structures to foam, the capacities of filters will be extended so a more manageable number of filters will be required, particularly for heavier castings (Figure 6). For example, a 22 tonnes ductile iron windmill rotor hub may require 18 ceramic foam filters to be applied, this can lead to a complex gating system for the filter application and in some cases bypassing of safe filter application (Figure 7). The new STELEX Optiflow3D filters will facilitate the need for fewer filters, and the possibility to filter even larger castings.



Figure 6. 22 pieces of STELEX ZR applied to a large SG Iron casting requiring Holloware for each filter



Figure 7. 18 pieces STELEX PrO 150x150x30/10 ppi applied to an iron windmill rotor hub

CASE STUDY 1: METALLWERK FRANZ KLEINKEN GMBH, WULFEN (GERMANY)

Metallwerk Franz Kleinken GmbH, Wulfen (Germany) is a foundry with more than 100 years of experience for castings up to 30 tonnes in weight. Kleinken is a contact partner, specialist and problem solver for all challenges in the production and processing of individual castings and small series made of cast iron and non-ferrous metal castings.

Kleinken produces ductile iron “Cross Head” castings for application in die casting machines. Like most foundries facing rising energy and labour costs they are looking to optimise workflows through improved application technology. Conventionally the castings are produced with a running system; in this example a STELEX Optiflow3D Ø125 mm filter was applied in a Direct Pour application providing enhanced casting feeding, and yield improvement. Energy costs and labour costs are reduced by the application of the Direct Pour system increasing the casting yield and reducing the fettling area. In addition, the filter application assisted in the production of a casting with excellent integrity and surface finish.

The enhanced application of the high capacity STELEX Optiflow3D filter in the FEDEX SCK Direct Pour System eliminated the need for a running system and eased subsequent removal since the small feeder neck had a minimal contact area (Figures 9, 10 and 11). The casting was sound with very good finished surface quality achieved. The returns were reduced by 94 kg (10 %) and the fettling area by 75 % (116 cm²). This not only results in cost advantages for the foundry but also represents a relief for the environment through lower CO₂ emissions. The filter delivered a molten iron capacity of 7.0 kg/cm², which is almost double of what is normally considered as safe for a 10 ppi ceramic foam filter. If a ceramic foam filter had been applied, it would have needed to be a Ø175 mm filter.

CASTING DETAILS:	
Alloy:	Ductile Iron (EN GJS 400-18)
Casting weight:	800 kg
Pouring temp.:	1350 °C
Pouring weight:	Conventional gating system - 959 kg STELEX Optiflow3D SCK Direct Pour - 865 kg
Pouring time:	Conventional gating - 50 s STELEX Optiflow3D SCK Direct Pour - 40 s
Moulding Process:	Hand moulding / Furane

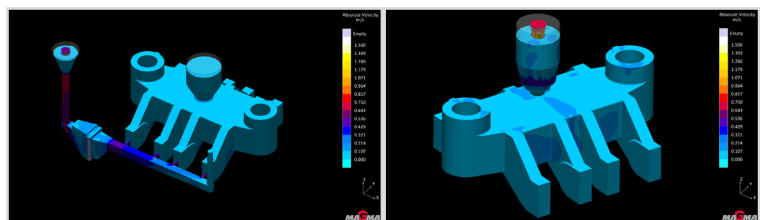

Figure 8. Magma representation comparing the conventional gating system (left) with the Direct Pour solution (right)

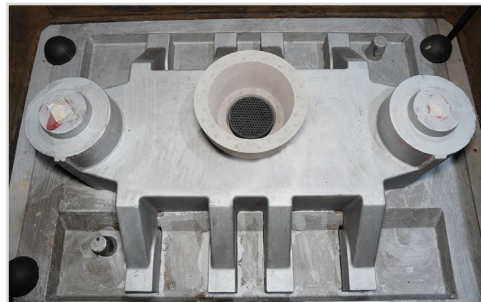

Figure 9. The STELEX Optiflow3D filter on the pattern plate

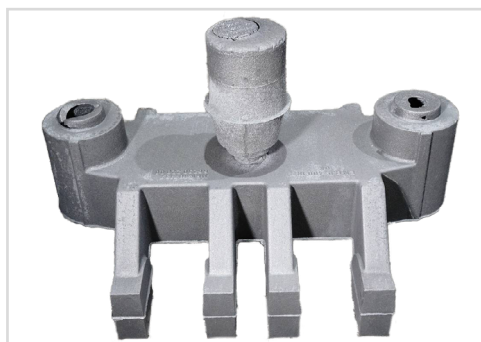

Figure 10. The casting

CASE STUDY 2: EICKHOFF GIESSEREI GMBH, BOCHUM (GERMANY)

Eickhoff Gießerei GmbH is part of the Eickhoff Group, a globally active family business which has been based in Bochum, Germany since its foundation in 1864. In addition to the foundry, the Eickhoff Group's portfolio includes mining machines as well as industrial and wind power gearboxes.

This application example of the STELEX Optiflow3D involves a planet carrier made of low-alloy steel. This casting is normally made without filters and with ceramic hollowware. In addition to the STELEX Optiflow3D Ø100x25, new HOLLOTEX EG Runner ST tubes suitable for steel casting and a 3D-printed filter holder were used for the revised casting system (Figure 11).

By using STELEX Optiflow3D filter, 3D-printed filter holder and HOLLOTEX EG Runner ST tubes, the casting weight was reduced by 8 kg and the surface quality slightly improved. Process-related non-metallic inclusions from the melting process were retained by the filter (Figure 12). Due to its manufacturing process, the filter provides a very consistent, reproducible structure allowing reliably high metal throughput in steel casting. The specific filter capacity of the STELEX Optiflow3D filter in this application was 3.9 kg/cm².

CASTING DETAILS:			
Alloy:	GS 17 CrNiMo 6 V		
Casting weight:	230 kg		
Pouring temp.:	1610 °C		
Pouring weight:	Conventional gating system	317 kg	
	STELEX Optiflow3D	309 kg	
Pouring time:	Conventional gating	21 s	
	STELEX Optiflow3D	24 s	
Moulding Process:	Hand moulding / Furane		

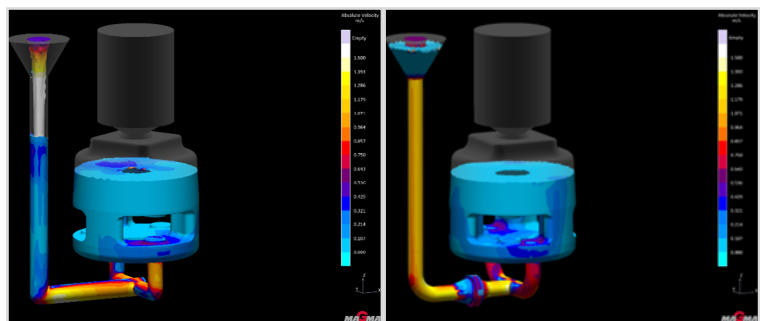

Figure 11. Magma representation comparing the conventional gating system (left) and the revised solution (right) using the STELEX Optiflow3D filter



Figure 12. The planet carrier produced with STELEX Optiflow3D after shake-out

SUMMARY AND CONCLUSIONS

Ceramic foam filters are the state-of-the-art metal filtration system used to produce castings in most alloys and casting technologies. Due to their unique effect in terms of filtration efficiency and flow control they are superior to any other filtration media available up to now. However, they also show structural restrictions with regards to porosity and flexibility in design.

Additive manufacturing technologies (3D Printing) are allowing the next major advance in casting filtration technology providing almost unlimited freedom in terms of structure, porosity and shape of the filtration media. The new STELEX Optiflow3D filters will facilitate the need for fewer filters, and the possibility to filter even larger castings made from iron and steel.

ABOUT THE AUTHOR

Nick has worked for Foseco since 1982. His job includes marketing responsibilities for clean metal systems, including filters, used in the production of castings. This includes ensuring that our products, services and R&D activities are aligned to our customers' requirements and processes. Nick strives to ensure that our technical experts and customers understand optimum filter application to maximise the benefits that can be achieved.

In his spare time Nick is a trustee of a leading UK charity, an active grandfather and enjoys swimming and keep fit.

GET IN TOUCH WITH NICK

 click on the linkedin icon to get to his profile

 nick.child@vesuvius.com



NICK CHILD
International Marketing Manager
Clean Iron & Steel

ABOUT THE AUTHOR

Stephan originally studied mineralogy and started his career at Foseco as a diploma student in steel filter development 25 years ago. Since then, he has held a variety of technical roles including cast iron metallurgy product management and is now European Product Manager Ferrous Filtration.

Stephan is the father of three daughters and a keen swimmer and cyclist.

GET IN TOUCH WITH STEPHAN

 click on the linkedin icon to get to his profile

 stephan.giebing@vesuvius.com



STEPHAN GIEBING
European Product Manager
Ferrous Filtration



HOLLOTEX* EG RUNNER ST - THE LIGHTWEIGHT ALTERNATIVE TO CERAMIC GATING SYSTEMS, NOW ALSO AVAILABLE FOR STEEL CASTING!



Authors: Andreas Baier and Stephan Giebing, Foseco Europe, Borken, Germany

HOLLOTEX EG Runner, introduced in 2009, revolutionised the construction of gating systems for hand-moulded iron castings. It eliminated the need for ceramic components and gained popularity in the European and American iron casting markets. However, it had limitations in withstanding high pouring temperatures used in steel casting.

To address this, HOLLOTEX EG Runner ST was developed with an optimized formulation and a refractory coating. Additionally, the shape of the components was modified to improve the flow distribution of molten metal.

INTRODUCTION

The introduction of HOLLOTEX EG Runner in 2009 provided for completely new opportunities in the construction of gating systems for hand moulded iron castings. Conventionally, wherever gating systems could not be incorporated on the pattern plate, ceramic components had to be used. Following a tentative start, the system was finally established in the European and American iron casting markets in 2011, with a demand of several hundred thousand units.

In addition to the simple handling and application benefits of HOLLOTEX EG Runner, the system was also appreciated by users as it eliminated the need for removal of refractory pieces of the used hollowware from the sand system.

However, since the product consists mainly of cellulose, mineral components and carbon fibres for integrity, it could not withstand the high pouring temperatures used in steel casting. Consequently, the use of HOLLOTEX EG Runner was limited to iron casting with pouring temperatures of up to 1450 °C. For this reason, the challenge was taken up to develop a system for higher pouring temperatures. In addition to optimising the organic and inorganic raw materials, an additional internal, highly refractory, coating of the pipes has been introduced in the production of HOLLOTEX EG Runner ST (Figure. 1).

Furthermore, the shape of components of the HOLLOTEX EG Runner ST have been optimised. Casting trials have revealed that the 90° deflection of the molten metal flow by the L-pieces resulted in turbulence, and metal chocking, during the direction change. This issue was addressed by the introduction of a less acute bend giving a more even flow distribution (Figure 2).



Figure 1 a+b. HOLLOTEX EG Runner ST components with high-temperature resistant internal coating

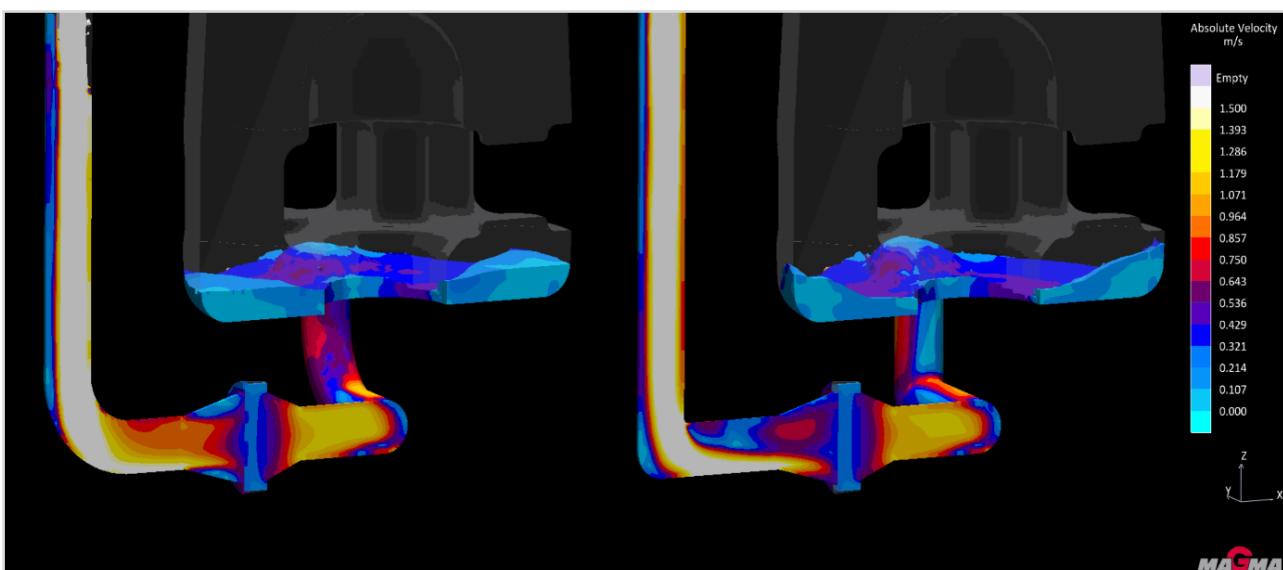

Figure 2. The bend on the left shows significantly more uniform flow velocities across the pipe diameter compared to the L-piece on the right

ADVANTAGES OF HOLLOTEX EG RUNNER ST

The HOLLOTEX EG Runner ST casting system provides the following advantages:

Simple assembly

Pipes, elbows and T-pieces provide an enlarged diameter at one end, enabling push-fit connection. The individual HOLLOTEX EG Runner ST components are simply inserted into each other at their ends. They can be joined without gluing to form the required configuration (Figure. 3).

Low weight

The low weight simplifies the preparation of the gating system. Due to its quick assembly an increased productivity in mould production is achieved. It also reduces the physical strain on the employee who assembles the gating systems. Due to the low weight, cross joints can be formed without the need for time-consuming gluing of the pipes with adhesive tape or hot glue. The use of reinforcements supporting the gating system is no longer necessary, eliminating the need for removal from the moulding sand during reclaim.

Easy to cut

HOLLOTEX EG Runner ST is easy shortened by using a hand saw (Figure. 4). This means there is only a marginal exposure to dust. In comparison, dry cutting of ceramic gating systems generates dust, and wet cutting requires the pipes to be dried afterwards. To assist in the accurate cutting of the tubes, a scale is shown on the outer surface of the tubes.

Simplified warehousing

The use of HOLLOTEX EG Runner ST significantly simplifies stockkeeping. Due to the simple shortening, all components are available in one standard length only. As a result, there is no need to keep stock of different pipe lengths.

Less residues and waste

Due to the composition of HOLLOTEX EG Runner ST, there is almost no contamination of the sand system. In addition, there is no need to remove ceramic fragments. The low weight, which is only approx. 1/10 of that of a ceramic system, also reduces disposal costs.



Figure 3 a+b. Ready-assembled gating system. Simple assembly due to the push-fit connection



Figure 4. Simple cutting using a hand saw

APPLICATION/INSTALLATION OF THE HOLLLOTEX EG RUNNER ST GATING SYSTEM

As with the system for iron casting, care must be taken to ensure good compaction of the moulding sand in the immediate vicinity of the HOLLLOTEX EG Runner ST system. Trials have confirmed pouring temperatures of up to 1600 °C can be used. Casting weights of up to 5 t have been produced so far. Compression of the pipes across the diameter should be avoided to prevent damage to the inner coating.

SUMMARY

HOLLLOTEX EG Runner ST is now also providing an alternative to conventional ceramic gating systems for steel foundryman. Currently, diameters of 50 and 70 mm are available. As the system becomes established among steel foundries, further diameters will follow. We recommend the use of HOLLLOTEX EG Runner ST for casting temperatures of between 1450 and 1600°C.

ABOUT THE AUTHOR

Andreas has worked at Foseco since 1986 and is currently Technical Manager Ferrous Foundry Department Germany. In his technical leadership role, he is responsible for the technical application of all FOSECO products. Andreas acts with his team as an interface between customers, development and production. Andreas enjoys cycling, hiking and sports in general. He likes watching football especially from his most favorite team, Bayern Munich.

GET IN TOUCH WITH ANDREAS



click on the linkedin icon to get to his profile



andreas.baier@vesuvius.com



ANDREAS BAIER
Technical Manager Ferrous

ABOUT THE AUTHOR

Stephan originally studied mineralogy and started his career at Foseco as a diploma student in steel filter development 25 years ago. Since then, he has held a variety of technical roles including cast iron metallurgy product management and is now European Product Manager Ferrous Filtration. Stephan is the father of three daughters and a keen swimmer and cyclist.

GET IN TOUCH WITH STEPHAN



click on the linkedin icon to get to his profile



stephan.giebing@vesuvius.com



STEPHAN GIEBING
European Product Manager
Ferrous Filtration

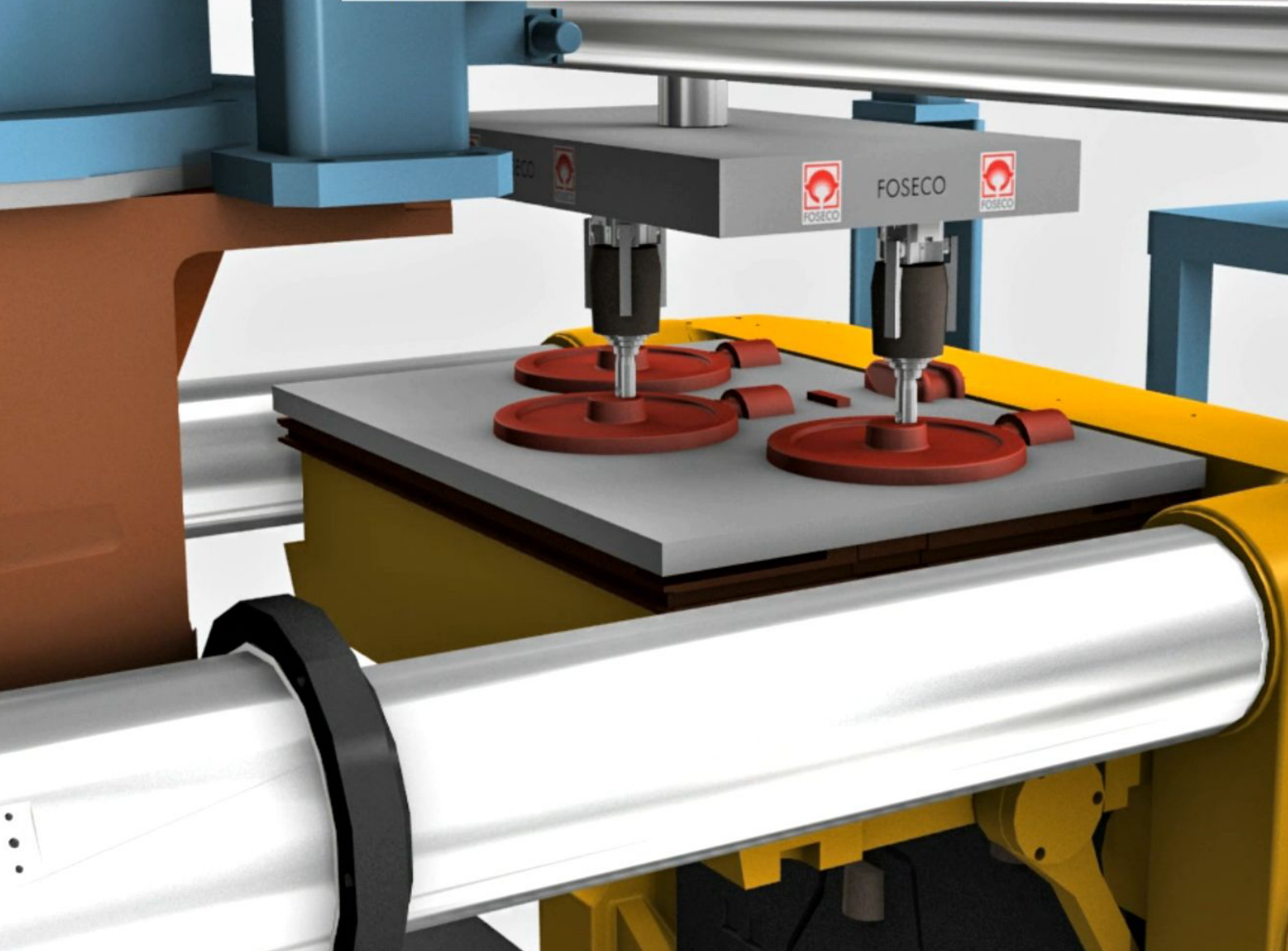

APPLICATION OF FEDEX K ON DISAMATIC MOULDING LINES



Authors: Christof Volks, Foseco Europe, Borken, Germany and Marc Mauhay, Foseco Taiwan

DISA's introduction of vertically parted moulding machines to the foundry market in 1962 revolutionised the industry with their high productivity and low process costs. Over time, efforts were made to increase the yield of DISA castings, including the use of feeder sleeves and direct pour systems. While feeder sleeves placed on the joint line of the mould improved casting yield and productivity, challenges arose with their application. The degree of utilization on vertically parted moulding lines was lower than on horizontal lines, but market pressures have led to heavier and more complex ductile iron parts being produced on vertical lines. Spot feeding techniques have emerged as a solution, and modifications have been made to spot feeders to address these challenges. In this paper, we will explore the impact of these advancements on the foundry industry.

INTRODUCTION

DISA introduced vertically parted moulding machines to the foundry market during 1962. The high productivity and the resulting low process costs of this concept paved the way to success for this type of machine moulding lines. The initial approach to feed DISA castings was the use of sand risers. To increase the yield of DISA castings, efforts have been made in the past by introducing insert sleeves and direct pour systems. Applying feeder sleeves on the joint line of the mould is a common practice, which uses a core setter to position the unit(s) into a preformed core print. Besides an improved casting yield, in many cases feeder sleeves increase productivity as additional casting cavities can be located onto the pattern plate (Figure 1).

The practice of locating feeder sleeves on the joint can occasionally lead to problems however, for example if the sleeve moves out of position before mould closure.

In contrast to horizontal moulding lines, the degree of feeder sleeve application on vertically parted moulding lines is much lower. One reason is the fact that a high proportion of castings produced on DISA moulding lines are grey iron parts. Standard feeder applications placed in the joint line as side or top risers were able to satisfy the feed demands of these castings.

Market price pressure and the lower production costs associated with DISA lines have increased the number of heavier and more complex ductile iron parts moving to vertical moulding lines. Practices such as metal padding that create a feed path to isolated sections, were used initially to enable the manufacturing of such parts. However, this approach was of limited benefit, as it resulted in reduced yield and increased fettling costs (Figure 2).

Initial efforts to use spot feeding for applications on vertical moulding lines started as early as 2006. At this time, simply using a modified spot feeder with a standard silica sand breaker core. In this case, three guiding ribs were introduced into the internal cavity of the sleeve, providing a support on the locator pin (Figure 3).

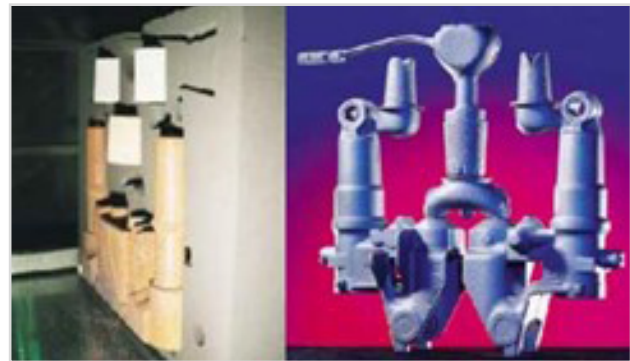

Figure 1. Application of direct pour unit and insert sleeves to a ductile iron casting

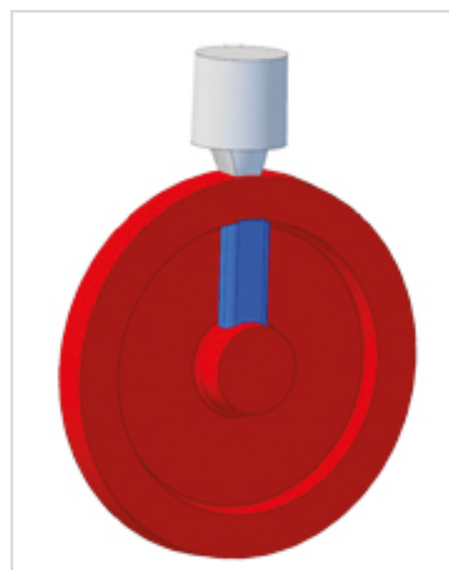

Figure 2. Metal padding to create a feed path through to a central boss on a typical disc casting

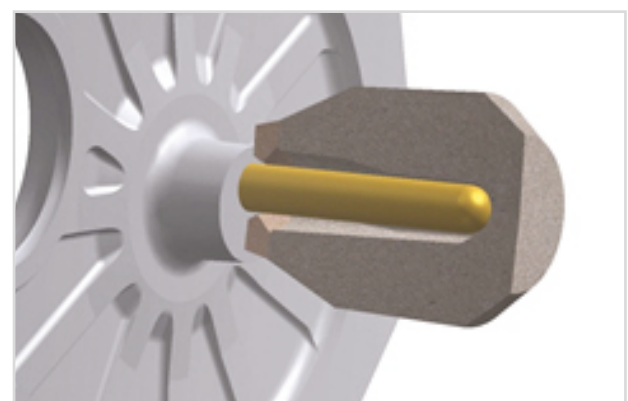

Figure 3. Casting with isolated boss fed by a spot feeder with sand breaker core

This method was the first approach to introduce spot feeding onto a vertical parted moulding line. Even though this application technique avoided metal padding, it had some disadvantages:

- Insufficient sand compaction in the area around the breaker core.
- Interruption of moulding cycles through manual application of sleeve on the pressure plate pattern, reducing productivity.

With regard to feed effectiveness however, first results achieved by the application of spot feeders were promising. Nevertheless, it was clear that from a commercial perspective further improvement of the method was necessary to enable an automatic sleeve application. A project was therefore initiated to further develop this type of spot feeding application for DISA moulding lines.

The main goals of the project were:

- Application of spot feeders without increasing the cycle time of a DISA moulding line
- Provide a feeder sleeve concept with critical features such as a small contact / footprint area on the casting which resulted in sufficient sand compaction during the moulding process.

These feeding requirements were provided by the use of a spot feeder in combination with a collapsible metal breaker core. In order to maintain the cycle time of the moulding line, the use of a core setter was essential. During the moulding operation, where the mould is indexed forward out of the moulding chamber, the swing plate is accessible in a horizontal position for several seconds. This time is sufficient to place a feeder sleeve onto the pattern plate (Figure 4.)

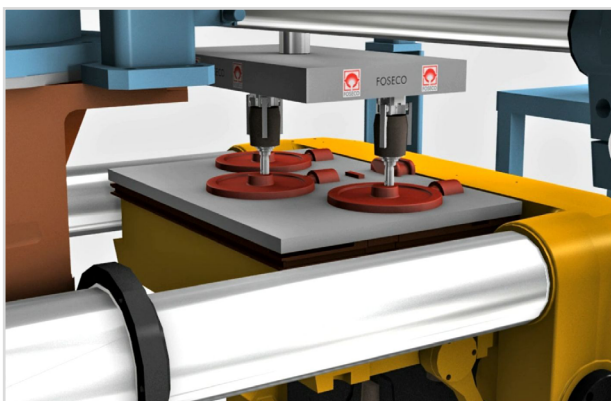

Figure 4. Application of feeder sleeves to the swing plate in a horizontal position

By the introduction of a sleeve setter robot, the application of feeder sleeves to the swing plate can be automated. Obviously, the sleeves must remain in their position on the locator pins as the swing plate moves down from the horizontal to the vertical position in the moulding chamber.

One option is to incorporate a spring-loaded ball to the pin base, which holds the feeder sleeve in place and stops it from falling off the locator pin. Alternatively, the sleeve can be held in position by the use of a ring magnet in the base of the locator pin. The magnet holds (steel) metal core in position, ensuring the sleeve remains fixed during the downward movement of the swing plate. Both methods have been tested successfully in the field, however the solution with a magnet in the spring base has the added advantage of requiring no maintenance.

The moulding behavior of spot feeder sleeves with collapsible metal breaker cores were tested in practice on a DISA moulding line. A clean contact area of the metal core on the mould face and excellent sand compaction beneath the sleeve were confirmed (Figure 5).

A wide range of test set-ups have been evaluated to determine the feed performance of spot feeders in the central position of a boss section. These trials were conducted on a generic disc casting, where feeding from the top of the casting through a 10mm thin wall section is not possible (Figure 6)

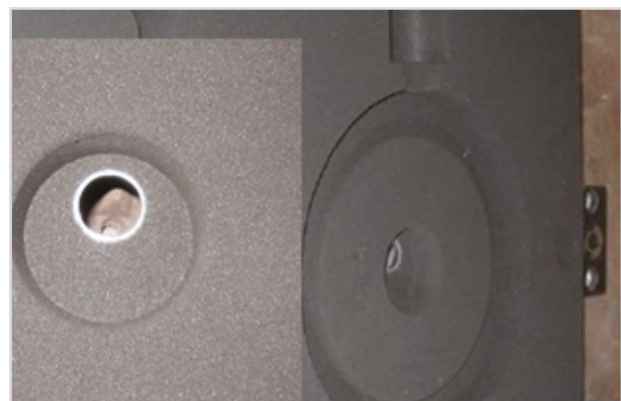

Figure 5. Moulding results on a generic plate casting with collapsible metal breaker core

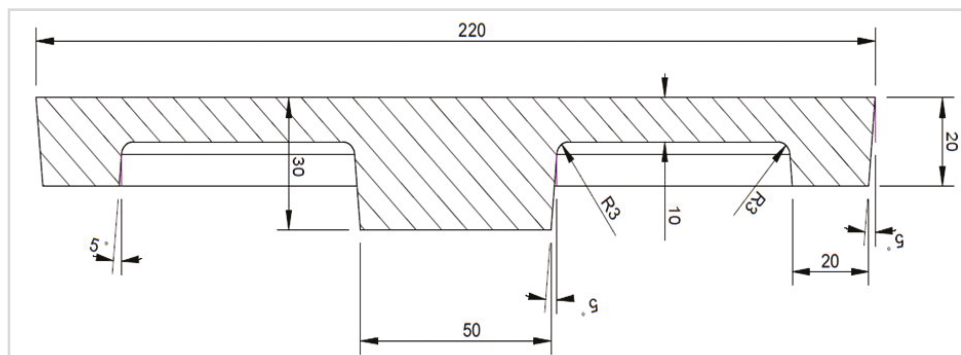

Figure 6. Layout of a generic disc casting

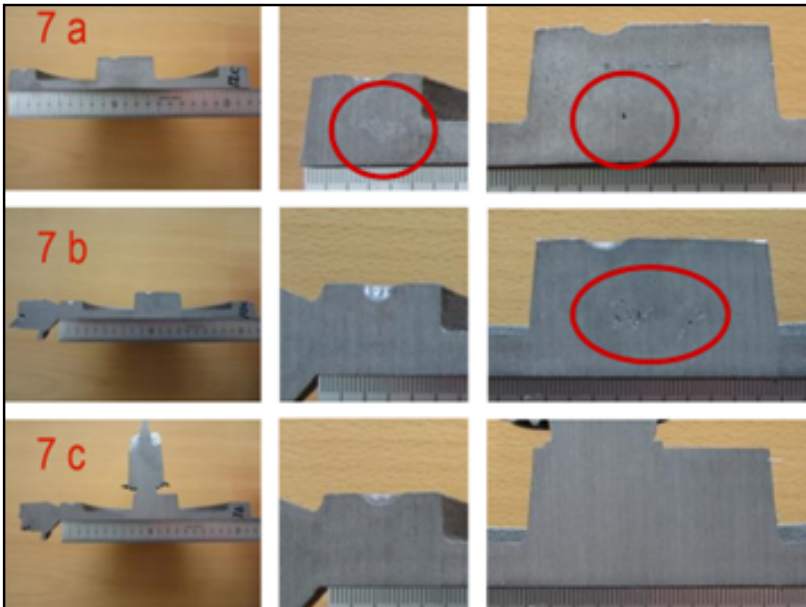

Figure 7a-c.
Test castings using different feeder configurations



Figure 8. Generic truck bracket casting fed with (3) inclined spot feeders



Figure 9. Spot feeder after knock-off, resulting in minimum residual stub

The different feed configurations were tested with a GGG 500 alloy, poured at 1405°C. [Chemical composition 3.7% C, 2.76% Si, 0.5% Mn, 0.015% P, 0.004% S, 0.044% Mg and 0.25% Cu.] Even using this hypereutectic ductile iron composition demonstrated an excellent result. The test casting (7c) with both top and central spot feeder was sound, the casting with only a top feeder (7b) showed clear porosities in the region of the centre boss.

Casting trial Figure 7a was conducted as a blank test to measure the feed requirement. It showed porosity in both the flange and boss areas.

The test demonstrated that even when used in a horizontal orientation a highly exothermic spot feeder in combination with a collapsible metal breaker core can work effectively. The promising feed results were also backed by excellent knock off / riser removal properties. As a result of the small contact area the majority of the feeders fell off during shake out operations. The notch incorporated at the bottom of the metal breaker core provides an even break off area, reducing or even eliminating additional fettling work.

Further tests conducted with a generic truck bracket casting also confirmed the viability of the spot feeding concept (Figure 8).

In this case, where feeding from the parting line without metal padding is not possible, inclined spot feeders in combination with a collapsible metal breaker core were applied. This design provides additional metalostatic pressure (due to the inclination of the sleeve) to ensure a consistent feed into the cast part.

Again, the advanced metal core design provided excellent knock off results (Figure 9).

CHENG PAO FOUNDRY, TAIWAN

These encouraging test results stimulated foundries to adopt this technology. One of them is CHENG PAO in Taiwan, where a project for this application technology was launched beginning 2021.

CHENG PAO were starting to use their newly installed DISA 2110 MK3 at this time and the FEEDEX* K product was proposed to them. This foundry is eager to cast high quality and demanding castings to fully utilize the capability of the DISA 2110 MK3.

It was not an easy task in the beginning and many challenges were met along the way. First to mention is the change from an older moulding machine to the new one. Secondly, the search for castings to fill their new capacity also presented challenges, as most of the parts they targeted were already being successfully produced on horizontal moulding lines. Lastly, the demand for efficient machine utilization, whilst delivering higher casting quality and reliability has never been greater. CHENG PAO were open to challenging the normal approach and were interested to work with FOSECO to develop this new feeding approach.

The introduction of FEEDEX K eventually resulted in the request for three Methoding projects – all clutch parts. One for a clutch cover on the DISA 2110 and the other two parts on the DISAMATCH 24/28 – which used also used FEEDEX sleeves. The methods required each one of FEEDEX HD1 GK 4/7KW/ 34MH for spot feeding, insulating insert sleeve KALMIN* KSP 3/5KT as top feeder sleeve, and SEDEX* US 40x40x11mm for filtration (Figure 10).

The heavy section in the centre of the the cast part cannot be fed from the outside and requires spot feeding. Several MAGMA simulations were conducted to develop the optimum setup. (Figure 11)

The first trial was conducted in March with ten (10) moulds. The tests revealed that the sand strength was low, pattern drafts were insufficient, some feeder sleeves broke due to inadequate application and pouring temperature was too low. As series of corrective actions were implemented, followed by subsequent trials and by July the casting was in mass production (Fig 12 a+b).

This success opened the door for further applications of FEEDEX sleeves on two more clutch parts and five other projects. During this project a partnership developed between CHENG PAO and FOSECO, which enabled further castings to be successfully methoded and fed using this ram-up spot feeding technology.

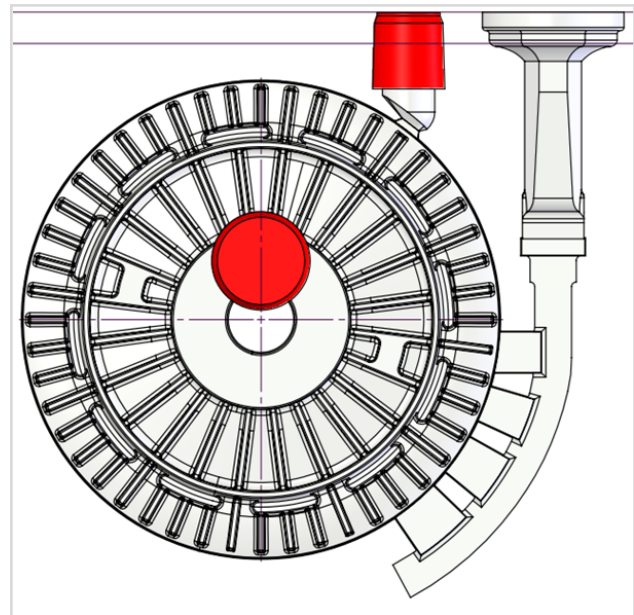

Figure 10. Pattern plate layout

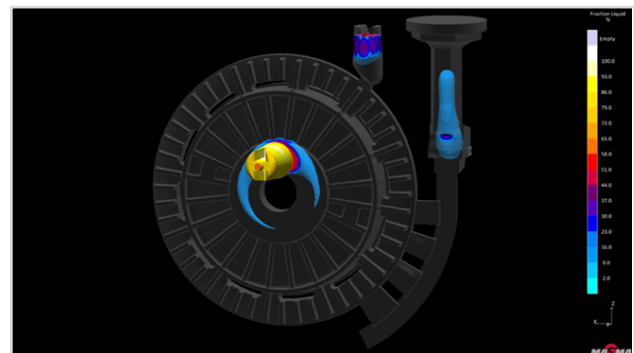

Figure 11. MAGMA result/ fraction liquid



Figure 12 a+b. Photos of section feeders and cast part after feeder knock-off

REFERENCES

1. Scherer, M., German Patent No. 3418137, October 02nd 1986
2. Powell, C., Sällström, J., Pehrsson, J. E., European Patent No. 1567294, May 5th 2006

ARE WE ALREADY CONNECTED?

Make sure you don't miss a new product, a webinar or the latest news about us.





linkedin.com/company/foseco

ABOUT THE AUTHOR

Christof has worked for Foseco since 1998. In his job as European Product Manager for Feeding Systems, Christof acts as an interface between customers, development and production.

GET IN TOUCH WITH CHRISTOF

 click on the linkedin icon to get to his profile

 christof.volks@vesuvius.com



CHRISTOF VOLKS
European Product Manager
Feeding Systems

ABOUT THE AUTHOR

Marc has worked for Foseco since 1987. He worked until 2020 as Feeding Systems and Filtration Product Manager. Currently his role is Marketing and Technology Manager.

In his spare time his hobbies are RASPBERRY PI home projects, listening to music mostly 70's to 80's, mellow jazz, classical. For exercise, outdoor cycling, and indoor training.

GET IN TOUCH WITH MARC

 marc.mauhay@vesuvius.com



MARC MAUHAY
Marketing & Technology Manager
Taiwan



FLUORIDE EMISSION FREE FEEDING SYSTEMS SOLUTIONS



Author: Christof Volks, Foseco Europe, Borken, Germany

Fluoride compounds have been used in foundries since the 1950s to initiate exothermic reactions in aluminum. Recently, there has been increased focus on fluorides, particularly their presence in feeder sleeves. Concerns include their impact on casting integrity and environmental legislation regarding fluoride disposal.

To address these issues, a range of fluoride-emission-free formulations have been developed, providing the same performance as their conventional counterparts. In order to achieve these results extensive research and trials have been carried out.

INTRODUCTION

Fluoride compounds have been used to initiate the exothermic reaction of Aluminium since Foseco introduced exothermic feeder sleeves in the 1950's. However, in recent years, foundries have paid increasing attention to fluorides in general and particularly the presence of fluorides in feeder sleeves has attracted some attention.

Initially the focus was on the impact of fluoride on casting integrity and the potential risk of surface defects such as "fish eye". Fluoride can enter the sand system from several sources such as the bentonite added to green sand, and of course the small amounts of fluoride present in exothermic sleeves.

Although the quantities of fluoride present are very low and measured as a fraction of a percent, under certain extreme circumstances, fluoride levels in the sand system can build up and, in such cases, the contribution from exothermic sleeves can be critical.

More recently attention has focused on environmental legislation. Regulation on the disposal of used foundry sand is tightening, and levels of potential land fill contaminants are strictly controlled.

Fluoride is increasingly specified as one of these "controlled" materials, and the presence of water leachable fluoride in sufficient quantities can have a significant impact on sand disposal costs.

For high strength ram-up spot feeders FEEDEX* FEF (Fluoride Emission Free) has been developed to consistently provide the same level of exothermic performance as conventional FEEDEX HD1. FEEDEX FEF is a new formulation for high density exothermic ram-up feeder sleeves, which eliminates the conventional initiator for the exothermic reaction.

FEEDEX FEF is designed to improve casting yield and feed performance and provide an identical modulus to the equivalent FEEDEX HD1. The table below compared the critical properties of the standard and FEEDEX FEF variants (Figure 1).

External laboratories have been used to test both formulations, FEEDEX HD1 and FEEDEX FEF to quantify and validate the water leachable fluoride content. (Figure 2).

Property	Unit	FEEDEX HD1	FEEDEX FEF
Density (GF - test body)	[g/cm ³]	1.51	1.61
density product	[g/cm ³]	1.42	1.52
permeability		180	170
CCS (GF - test body)	[kN]	> 25	> 25
Burn time, ox. *	[s]	110	225
T-max, ox.	[C]	1610	1509
t > 1150, ox.	[s]	320	291
T-max, red. *	[C]	1380	1449
t > 1150	[s]	275	288

Figure 1. Data represent typical values as measured on a standard laboratory sample.

	Sleeve Condition	Water leachable fluoride * [mg/l]
FEEDEX HD1	Not burned	50
	Burned	15
FEEDEX FEF	Not burned	1.2
	Burned	1.1

Figure 2. Water leachable fluoride content of burned unburned feeder sleeve material

The exothermic burn profiles of FEEDEX products are carefully designed and optimised as it is critical to match the heat output of the feeder sleeve to the solidification time of the feeder.

Performance of the FEEDEX FEF has been shown to be equal to conventional FEEDEX HD1 ram-up feeder sleeves. (Fig 3).

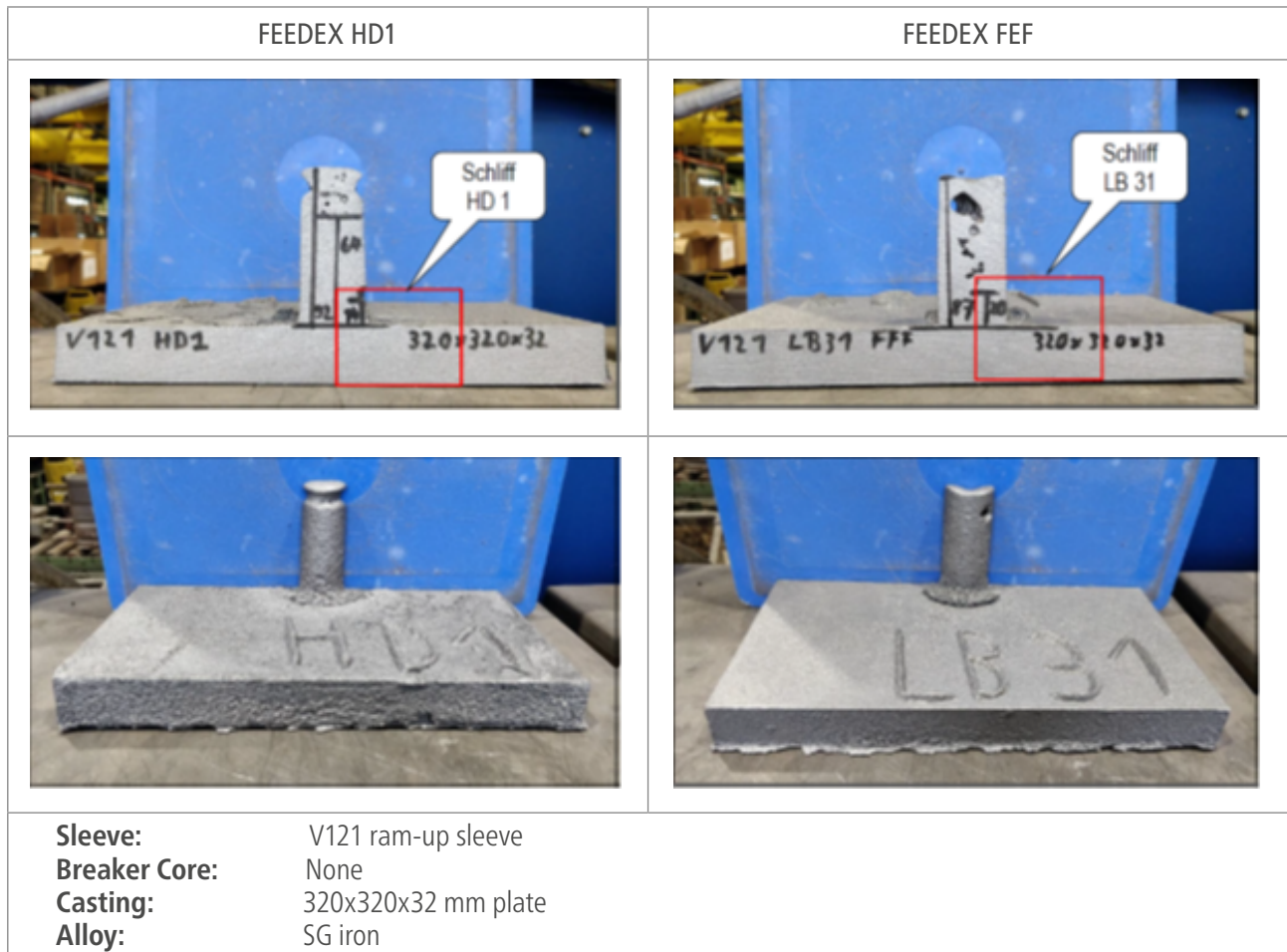

Figure 3. Comparative Ductile Iron plate tests with FEEDEX HD1 and FEEDEX FEF

Similar efforts were also made to develop a fluoride free insulating exothermic slurry form recipe. Extensive research and trials resulted in a fluoride free version of KALMINEX* 2000.

KALMINEX* 2000 FF is the only commercially available fluoride free, exothermic slurry form recipe in the market today. Fluoride free KALMINEX 2000FF feeder sleeves are highly effective in reducing riser size and providing consistent feeding performance in both iron and steel applications.

For foundries using the KALMINEX 2000FF products, the absence of fluoride enables the reduction of disposal costs for waste moulding sand. There is no requirement to use or pay for special disposal as the feeder sleeves contain zero fluoride.

Analogue to the tests conducted during the development of FEEDEX FEF a comprehensive range of tests were conducted to validate the performance of KALMINEX 2000FF (relative to the standard product).

These included,

- physical and thermo-physical laboratory measurements,
- step test castings in produced in green sand (Iron)
- steel cube castings and ductile iron plate castings to compare feed performance

Results confirmed KALMINEX 2000 FF has similar physical and thermo-physical properties compared to the standard formulation. (Figure 4).

	KALMINEX 2000	KALMINEX 2000FF
Density [gm/cc]	0.59	0.61
Compression strength [k.N]	3.9	4.7
Gas permeability [ml/min*cm ³]	30.6	32.7
Moisture content [%]	0.49	0.46
Ignition time [sec]	16.8	20.4
Burn time [sec]	86	127
Maximum temperature / GF body [°C]	1610	1646
Time over 1150 °C / GF body [sec]*	180	202

Figure 4. Comparative physical and thermo-physical tests

*single tests

Extensive casting tests proved a comparable performance in application (Fig. 5a + 5b)



Figure 5a. Ductile iron casting test with KALMINEX 2000 ZP 6/9K/11Q versus KALMINEX 2000 FF FZP 6/9K/11Q on a 250 x 250 x 25 mm plate. Both sleeves showed comparable feed safety margin

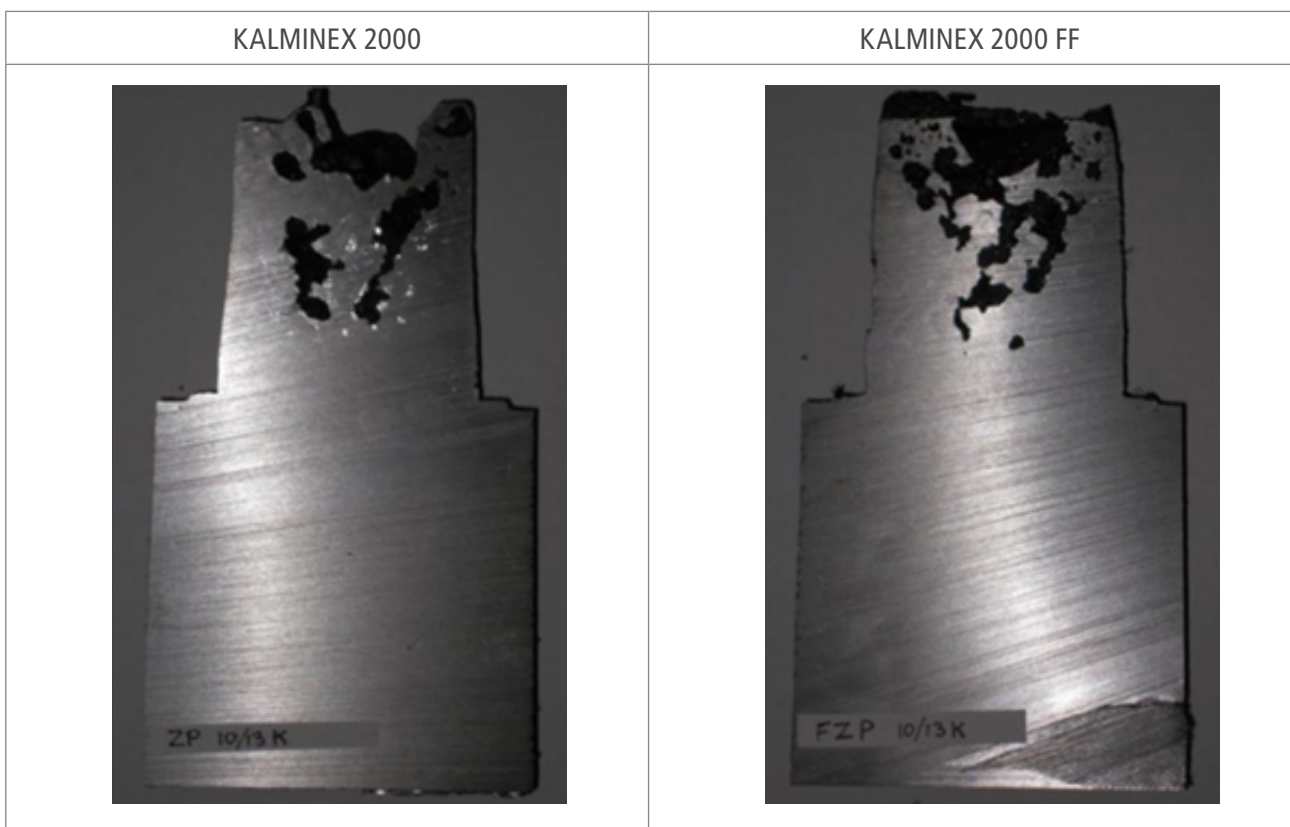

Figure 5b. Carbon steel casting test with KALMINEX 2000 ZP 10/13K versus KALMINEX 2000 FF FZP 10/13K on a 150mm cube, again both sleeves with comparable feed safety margin.

Tests were established to determine the contamination effect of varying concentrations of burned sleeve residue in re-used greensand. Results were assessed by monitoring the incidence of casting surface quality defects. The addition rate was increased in incremental steps of 3% from 0 to 9%. A nominal addition of

3 % feeder sleeve residue in the sand, already represents many times the level typically encountered in most foundries.

Results confirm the neutrality of the KALMINEX 2000 FF contaminated sand compared to the standard product. (Fig. 6)

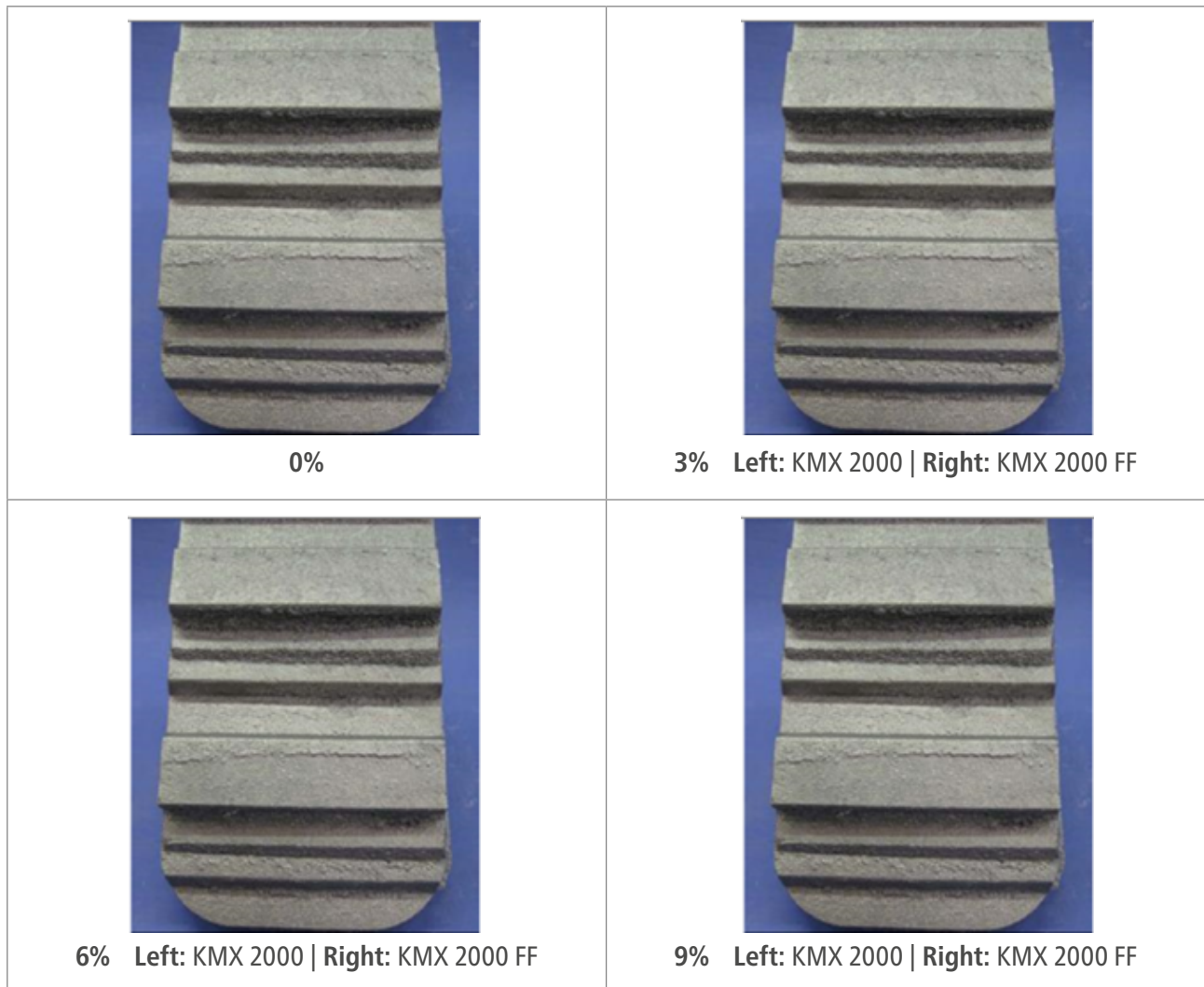

Figure 6. Neutrality of the KALMINEX 2000 FF contaminated sand compared to the standard product

SUMMARY

In summary, both formulations FEEDEX FEF and KALMINEX 2000 FF proved to be interchangeable with their conventional counterparts in terms of their thermos-physical properties and feed performances.

With the confidence gained by these tests, several customer trials were conducted which validated the results generated previously. The similar properties of FEEDEX FEF and KALMINEX 2000 FF with their standard product counterparts, enables foundries to easily convert from standard feeder sleeve products to fluoride emission free formulations.

There remain many environmental challenges ahead for foundries, including targets to reduce VOCs. FOSECO remains committed to work in partnership with our customers to develop the products they will require in the future in order to satisfy increasing regulation, whilst remaining commercially competitive.

ABOUT THE AUTHOR

Christof has worked for Foseco since 1998.

In his job as European Product Manager for Feeding Systems, Christof acts as an interface between customers, development and production.

GET IN TOUCH WITH CHRISTOF



click on the linkedin icon to get to his profile



christof.volks@vesuvius.com



CHRISTOF VOLKS
European Product Manager
Feeding Systems

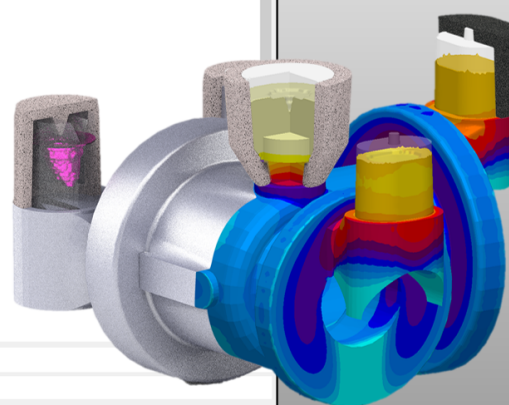
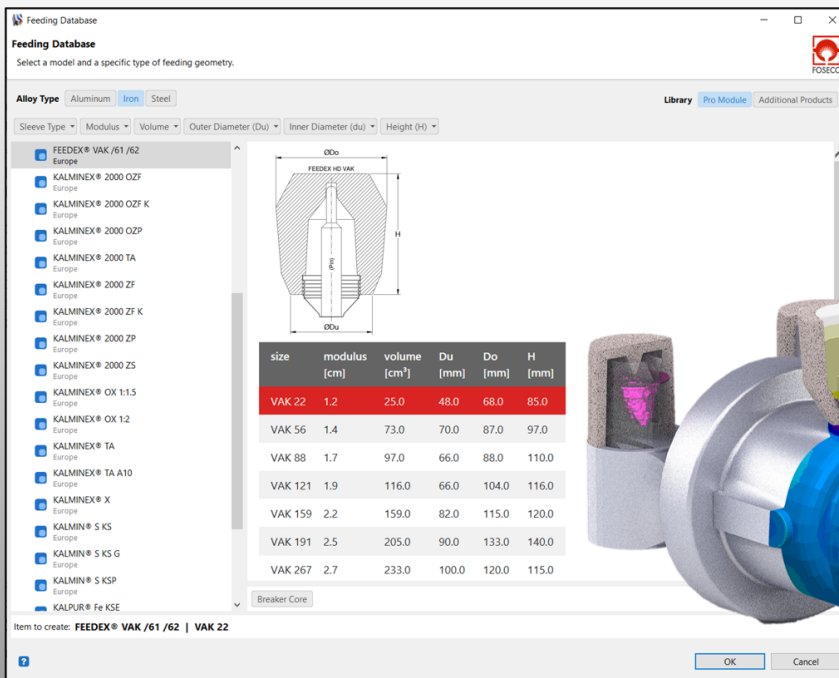
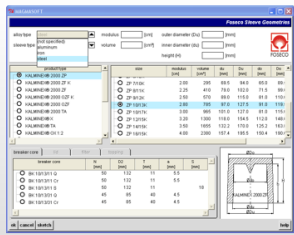

FOSECO PRO MODULE – Update 2023

THE FOSECO PRO MODULE FOR MAGMASOFT® - UPDATE 2023



Author: Máirtín Burns, Foseco Europe, France

This year, Foseco and MAGMA celebrate the 20th anniversary of their strategic alliance, with the release of a new version of the Foseco Pro Module.

It features an updated interface with new sleeve types, filter prints & additional complex geometries to accelerate the design of gating and risering systems in MAGMASOFT®6.0.

INTRODUCTION

The Foseco Pro Module is a special module exclusively for MAGMASOFT®, accessible only via a special license key. First launched in 2004, the Foseco Pro Module was the first 3D database of the standard portfolio of Foseco Feeding and Filtration products and their associated performance characteristics. Over the years, it has been regularly revised and expanded to cover more regional databases and is used by many foundries worldwide.

MAGMA have recently released the latest version of their well-known casting process simulation software, MAGMASOFT® 6.0, which features an intuitive new user interface and a fundamentally new user experience. Thanks to the special focus placed on efficiency, ease-of-use and time-to-answer, users analyse their results more precisely to make well-informed decisions, thereby reaching their objectives even faster.

The Foseco Pro module has now been updated and upgraded to meet growing demands in terms of usability and support for new Foseco products. This new, state-of-the-art version of the Pro module is fully integrated into the new MAGMASOFT® 6.0 user interface and allows the MAGMASOFT® user to review and select from the available Foseco product range, loading 3D assemblies of the respective geometries and product properties. The module continues to be fully compatible with MAGMA's unique Autonomous Engineering capabilities, enabling users to select the best possible products for the given quality requirements.

HOW DOES IT HELP THE CUSTOMER?

As a global leader in the supply of foundry consumables, Foseco product technologies aim to help foundries deliver the ever-evolving environmental, casting quality and performance requirements.

Updating and expanding the new Foseco Pro Module provides the MAGMA Simulation engineer with the geometries, material properties and some basic application guidance to be able to test and evaluate products important to the filling and feeding of castings. In the competitive world of foundries, this accelerates the experimentation of the solutions virtually, and ultimately lead to faster, better castings for the customer.

ACCESSING THE FOSECO PRO MODULE

Figure 1 shows how to access the Foseco Pro Module in the MAGMA 6.0 interface – and add it to the favorites bar!

Accessing the Foseco Pro Module in the geometry perspective of MAGMASOFT® 6.0 is via the "Import from database" pop-out menu. For frequent easy access, it is possible to add the Foseco Pro Module icon to a favorites bar by simply right-clicking on the logo as highlighted above. This places a Foseco icon in the toolbar at the top of the workspace, facilitating easy access.

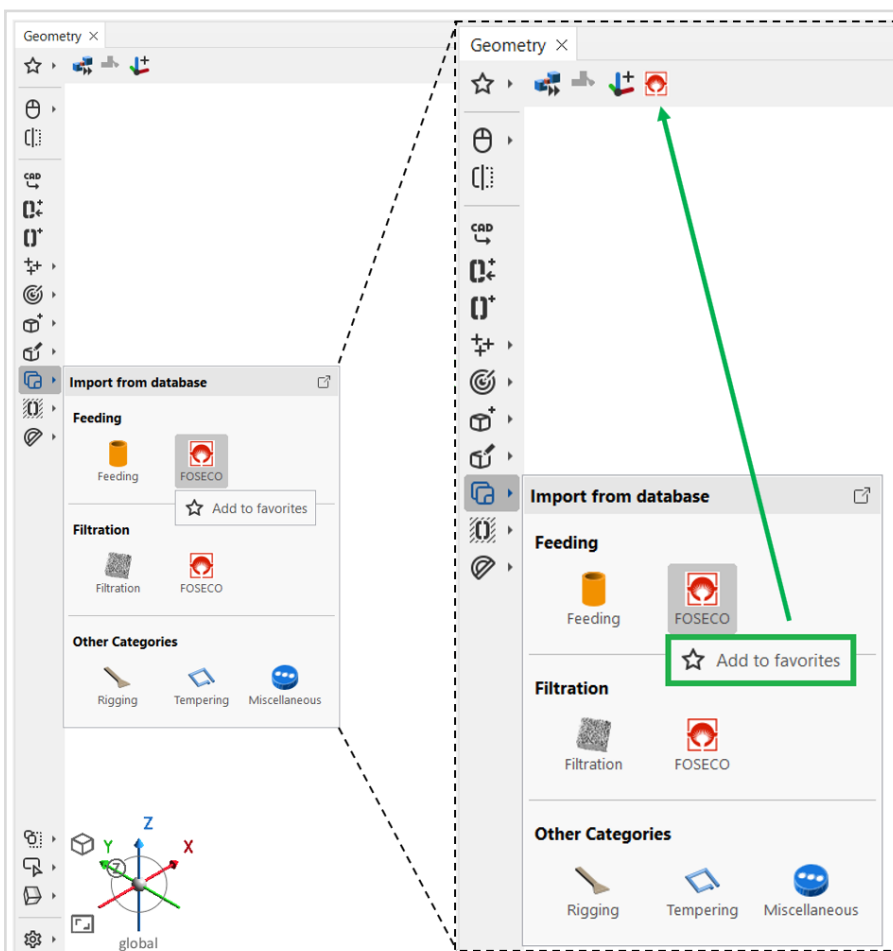

Figure 1. How to access the Foseco Pro Module in the MAGMA 6.0 interface – and add it to the favorites bar!

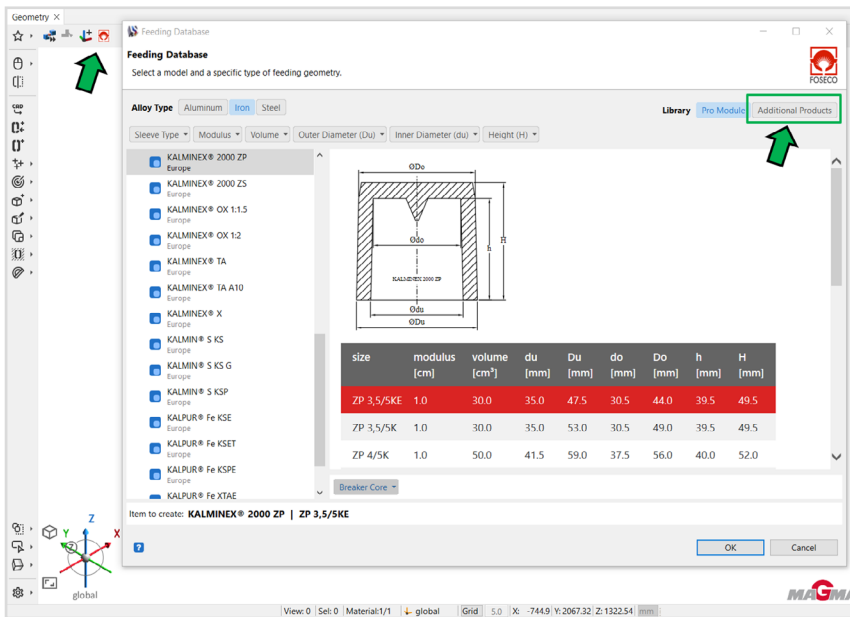

Figure 2. The Pro Module Feeding Database (showing combined libraries)

There are separate databases for Feeding and Filtration in the Pro Module. The geometries in these databases were all fully parametric with automatic assignment of material datasets; that was until geometries such as the FEDEX* SCK range were included in 2019. Such geometries were too complex to parameterize and were therefore included as a separate SCK geometry database with separate access.

The new interface combines these geometry types, parametric Pro Module types, and CAD/MAGMA geometry files in the same user interface, thus allowing the user to click between the different libraries, "Pro Module" & "Additional Products". This new and additional flexibility has allowed for the inclusion of a wider range of Foseco products and complex geometries directly into MAGMA, to run simulation analyses, optimisation and DOE studies.

PRO MODULE FEEDING DATABASE - NEW ADDITIONS AND FEATURES

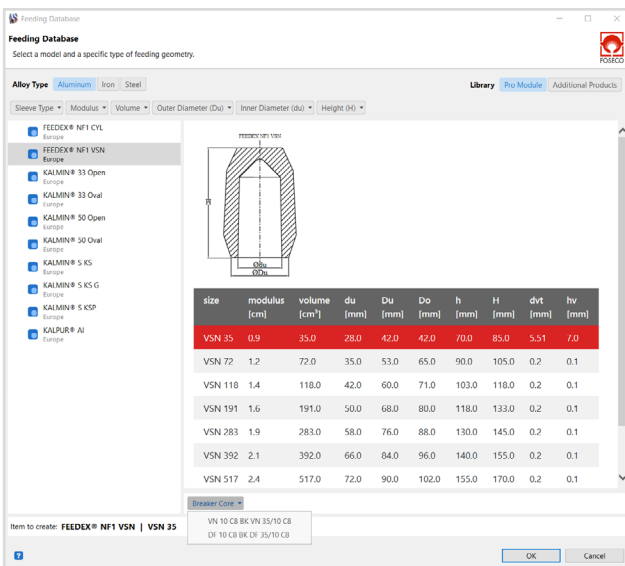

Figure 3. Addition to the Pro Module library is the FEDEX NF 1 range of Exothermic sleeves, for Non-Ferrous applications along with the associated breaker core options.

An example of a casting optimised using FEDEX NF 1 feeder technology will be shown on the FOSECO Stand at GIFA 2023 in Dusseldorf.

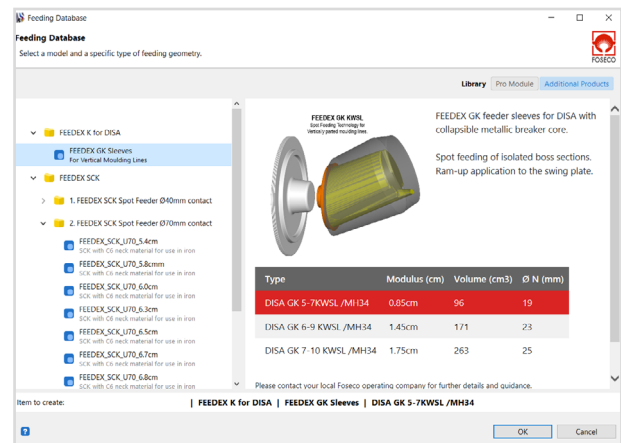

Figure 4. By clicking on the "Additional Products" button, the library changes to show the FEDEX SCK range. Newly available in this library is the FEDEX K for DISA range.

An example of 2 castings optimised using FEDEX K for DISA feeder technology will be shown on the FOSECO Stand at GIFA 2023 in Dusseldorf.



PRO MODULE FILTRATION DATABASE – ADDITIONS AND NEW FEATURES

(Metal) Cleanliness is next to Godliness! Metal quality, metal cleanliness and how a casting is filled have determining roles in the final casting quality. Foseco's range of filter products for iron, steel and aluminium cover a wide range of casting weights, and help to remove oxides and inclusions and reduce turbulence during filling.

Opening the updated Foseco Pro Module Filtration interface shows a catalogue of available filters and their dimensions. To help select the correct number and size of filters needed to filter a particular casting, maximum filtration capacity guidelines per filter have been added for certain alloys (see figure 5). Similar to the Feeding Database, the Filter database also includes an "Additional Products" button to access a second library of more complex filtration related geometries.

Figure 6 shows the list of metal filtration products has been expanded to include, KALPUR* FSC TA sleeves and FEDEX* SCK Direct Pour units, and the recommended filter prints for in-line filtration of iron and steel using SEDEX* and STELEX* filters. In addition, to assist the foundry man in pouring larger steel castings with requirement of mechanical properties, the Pro Module includes the range of HOLLOTEX* Shroud assemblies including shroud pouring tubes, diverters or filter boxes with integrated filters. The availability of all these geometries will accelerate the design of gating systems and the optimisation of the casting processes using MAGMASOFT®.

Figure 7 shows the HOLLOTEX Shroud system assemblies in the Pro Module as well as an example of a casting optimised using HOLLOTEX Shroud pouring system will be shown on the Foseco Stand at GIFA 2023 in Dusseldorf.

In combination with the ROTOCLENE* process, HOLLOTEX Shroud protects the metal liquid during filling, preventing air entrainment and re-oxidation, raising the casting quality to the highest levels. Castings produced with ROTOCLENE and HOLLOTEX SHROUD have improved casting surface finish, internal homogeneity, resulting in higher mechanical properties compared to conventional technology. Please see the related Foundry Practice article.

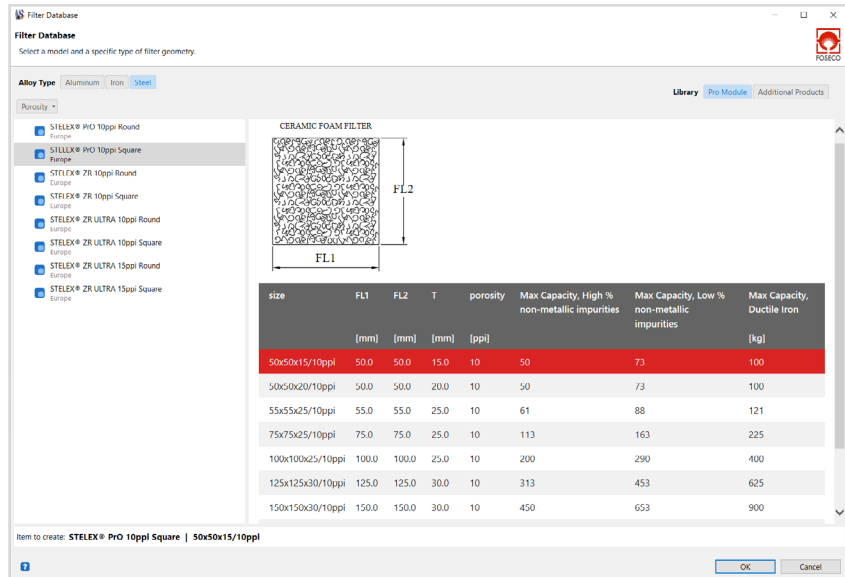

Figure 5 – Pro Module Filtration database

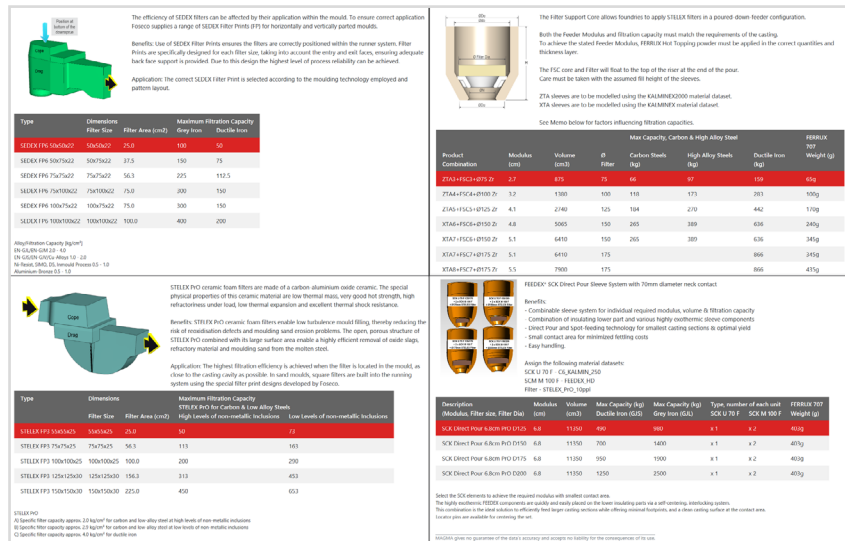

Figure 6. New geometries in the Filtration Database

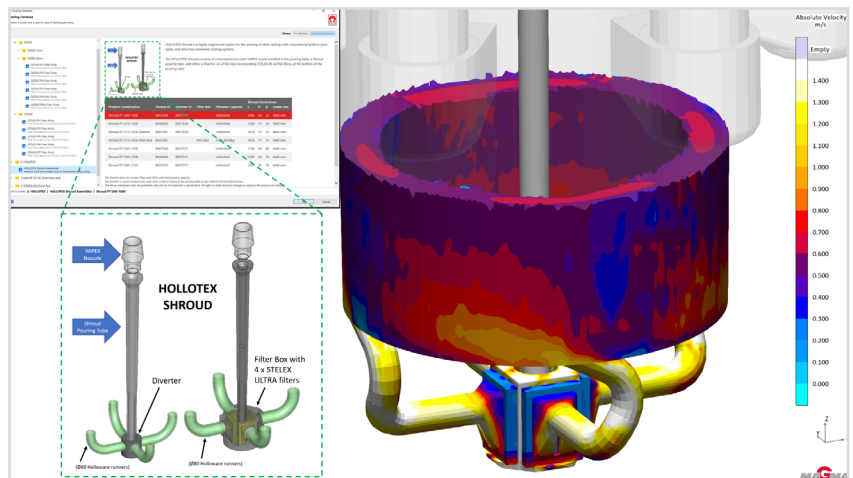

Figure 7. HOLLOTEX shroud geometries & example from GIFA



Figure 8 shows the newly added FEEDEX SCK Direct pour system as shown in the Foseco Pro Module Filtration database.

The FEEDEX SCK (Sleeve Construction Kit) was introduced at GIFA in 2019. Since then, the SCK range has expanded to include two modified neck pieces that can hold either Ø125, Ø150, Ø175 or Ø200mm filters, increasing the size of the casting that can be filtered for a particular modulus. The modulus range is from 5.4 to 7.1cm, with a filtration capacity range from 490kg to 1250kg of Ductile iron, depending on the filter size chosen.

CASE STUDY EXAMPLE

DEVELOPMENT WORK

Necessity is the mother of invention ! The development of new products often comes from trying to find solutions to particular problems or requirements. Foseco's Foundry R&D Centre is focussed on binders, coatings, feeding systems, filtration and metal treatment development. Equipped with state-of-the-art facilities for the analysis of

thermal properties, and an experimental foundry for the testing of prototypes and production of test castings, this R&D facility actively supports the development of new Feeding and Filtration products and new material datasets for use in the Foseco Pro Module. Future projects with MAGMA include the improving the modelling of flow through filters.

SUMMARY

Tools such as MAGMASOFT® 6.0 and its powerful Autonomous Engineering functionality, combined with the updated Foseco Pro Module and its portfolio of products/potential solutions are critical for the virtual optimisation of casting production methods. The combination of these tools with the knowhow and experience of the foundryman help to deliver optimal casting quality.

The continuous evolution in computer and foundry hardware and software pushing the limits of casting technology won't stop any time soon. FOSECO and MAGMA are committed to continuing their alliance, developing better tools and services for the benefit of their mutual customers.

ABOUT THE AUTHOR

Máirtín has worked at Foseco since 1997 and is currently European Simulation Manager. In his technical leadership role, he is responsible for the regional management of Foseco simulation service capabilities and tools such as the Foseco Pro Module. This involves interaction with simulation and application experts worldwide in combination with the team working in R&D. Máirtín enjoys walking and cycling in the great outdoors and watching rugby.

GET IN TOUCH WITH MÁIRTÍN

 click on the linkedin icon to get to his profile

 mairtin.burns@vesuvius.com



MÁIRTÍN BURNS
European Simulation
Manager

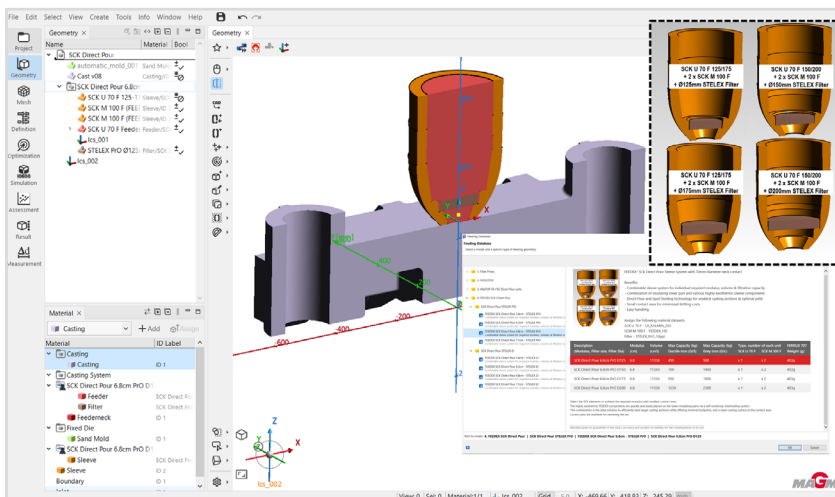

Figure 8. FEEDEX SCK Direct Pour units

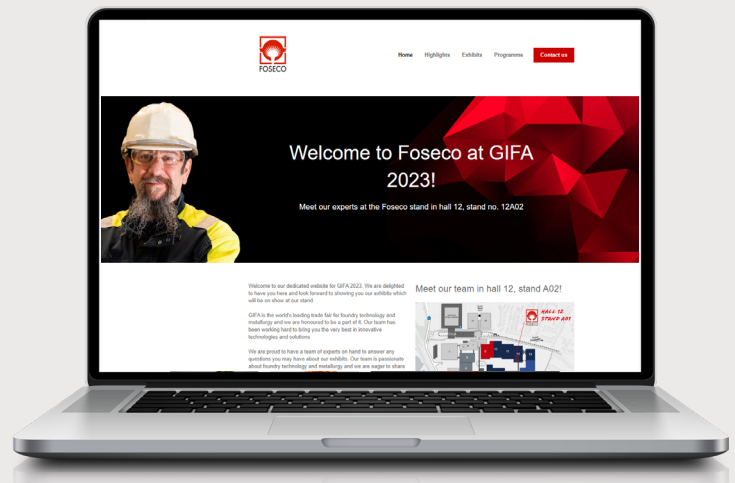

Figure 9. Foundry R&D Centre at Enschede

FOSECO AT GIFA

We have developed a dedicated GIFA website where you can find all the information you need about our presence at the event. Whether you can't make it, or just want to get a head start, our dedicated GIFA website is the place to be. Dive into a wealth of detail about our innovative products, technologies and industry-leading solutions that will be showcased on our stand.

Go to gifa.foseco.com



LET'S MEET!



GIFA 2023

12th - 16th JUNE, DÜSSELDORF

The foundry industry is changing, bringing new opportunities and challenges, particularly in sustainability. Quality, yield, and cost control remain critical to success. Join us at GIFA in Düsseldorf from June 12-16, 2023, to learn how we're shaping the industry's future, showcasing innovations, discussing sustainability, and sharing case studies. Let's work together to find solutions to your concerns and challenges.

VISIT US IN HALL 12
STAND NO. 12 A02

[linkedin.com/company/foseco](https://www.linkedin.com/company/foseco)



VESUVIUS

THINK BEYOND. SHAPE THE FUTURE.

All rights reserved. No part of this publication may be reproduced, stored in a retrieval system of any nature or transmitted in any form or by any means, including photocopying and recording, without the written permission of the copyright holder.

All statements, information and data contained herein are published as a guide and although believed to be accurate and reliable (having regard to the manufacturer's practical experience) neither the manufacturer, licensor, seller nor publisher represents or warrants, expressly or impliedly:

- (1) their accuracy/reliability
- (2) that the use of the product(s) will not infringe third party rights
- (3) that no further safety measures are required to meet local legislation

The seller is not authorised to make representations nor contract on behalf of the manufacturer/licensor.

All sales by the manufacturer/seller are based on their respective conditions of sale available on request.

*Foseco, the logo, KALPUR, FEEDEX, HOLLOTEX, KALMINEX, SEDEX and STELEX are Trade Marks of the Vesuvius Group, registered in certain countries, used under licence.

MAGMA and MAGMASOFT are registered Trade Marks of MAGMA Giessereitechnologie GmbH.

©Foseco International Ltd. 2023

COMMENT

Editorial policy is to highlight the latest Foseco products and technical developments. However, because of their newness, some developments may not be immediately available in your area.

Your local Foseco company or agent will be pleased to advise.

VESUVIUS
A VESUVIUS GROUP COMPANY

